

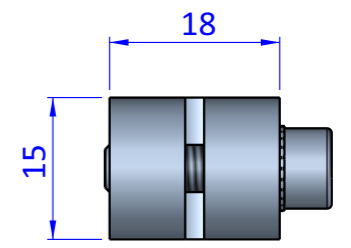

THE PROPERTY OF THE DRAWING IS ESTABLISHED BY LAW. IT IS FORBIDDEN TO PRODUCE OR SHOW IT TO THIRD PART. WITHOUT A WRITTEN AGREEMENT.

Item	Name	Q.ty
1	GLA.14.1.40	1
2	GLA.14.2	1
3	R.5.SCH	3
4	V.TCE5x18	2

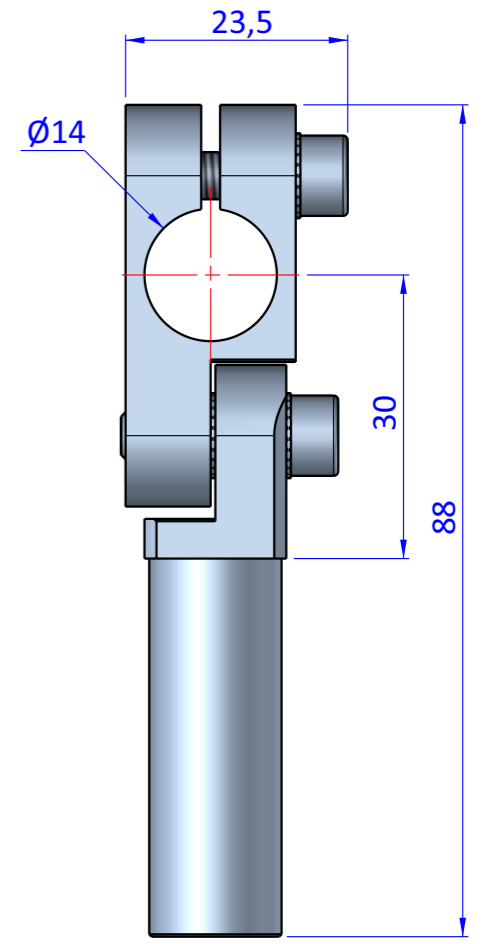
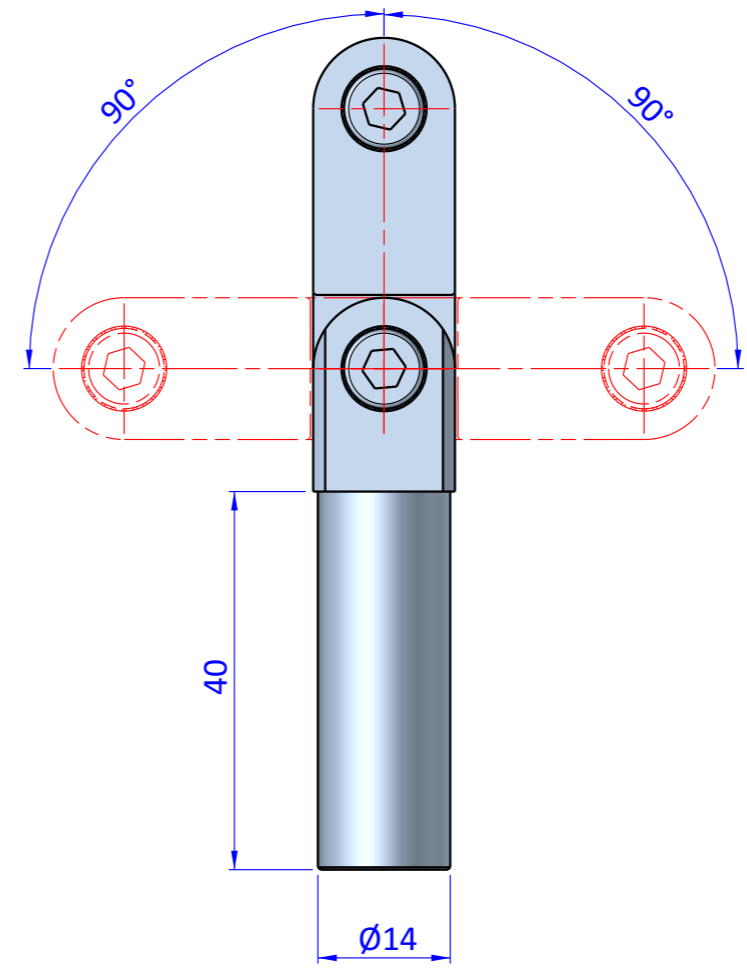
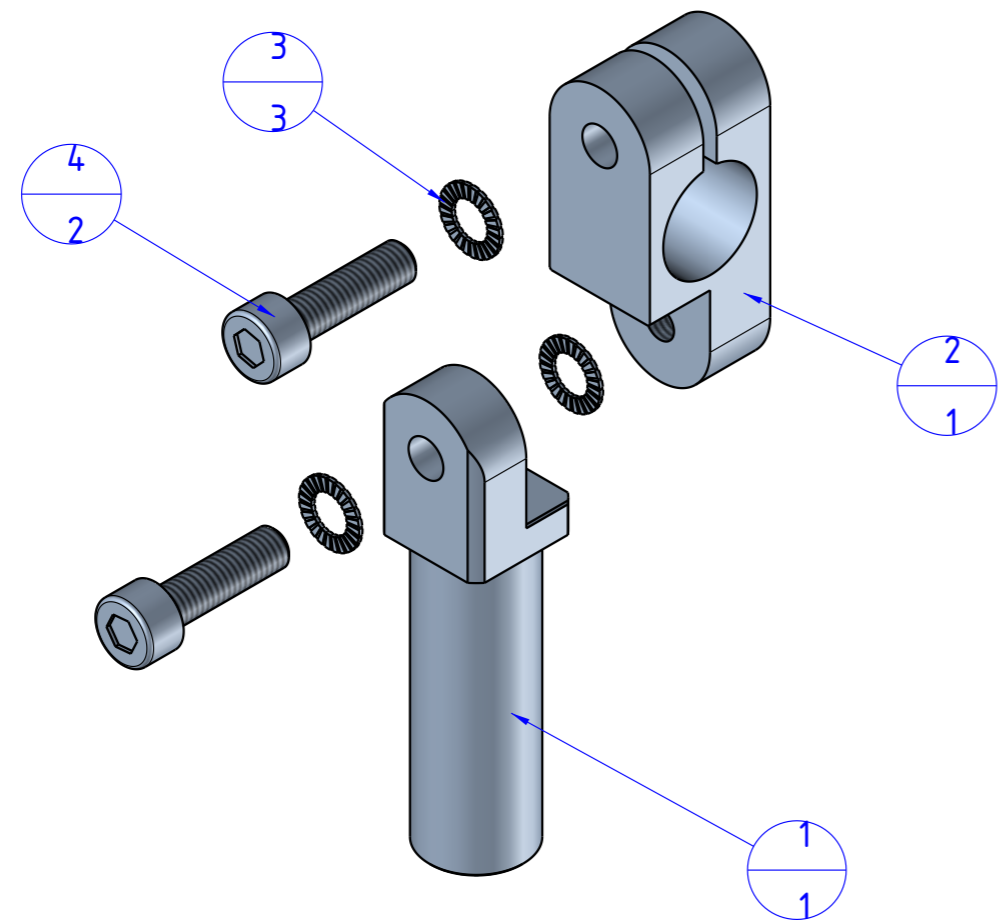

Format A3
UNI 936-76

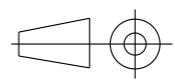
 FPS FPSERVICES AUTOMATION			DESIGNED FROM FPS Automation	REVIEW A
GENERAL TOLERANCE UNI - ISO 2768 CLASSE f	DESCRIPTION CA.GLA.1414.40		DATE 24/08/2020	WEIGHT 0,046kg
			CODE CA.GLA.1414.40	